

Clarke[®]

air



PORTABLE AIR CONDITIONER

MODEL NO: AC13050

PART NO: 3230578

OPERATION & MAINTENANCE INSTRUCTIONS

UK
CA | CE



ORIGINAL INSTRUCTIONS

GC11/22 - rev 2

INTRODUCTION

Thank you for purchasing this CLARKE Portable Air Conditioner.

Before attempting to operate the machine, it is essential that you read this manual thoroughly and carefully follow all instructions given. In doing so you will ensure the safety of yourself and that of others around you, and you can also look forward to the product giving you long and satisfactory service.

TECHNICAL SPECIFICATIONS

Model Number	AC13050
Power Supply	230V/50Hz
Weight	28 kg
Dimensions (L x W x H)	340 x 443 x 815 mm
Water Sump Capacity	0.55 L
Air Flow Volume	360 m ³ /h
Operating Temperature	15 - 35°C
Exhaust Duct Diameter	150 mm
Exhaust Duct Length (expanded)	1500 mm
Permissible Excessive Operating Pressure (suction/discharge)	1.0 MPa/3.5 MPa
Max Pressure (Low/High Pressure Side)	1.5 MPa/5.5 MPa
Sound Pressure Level	56 dB LpA
Sound Power Level	63 dB LwA
Guaranteed Sound Power Level	65 dB LwA
Energy Efficiency	EU Class A
Cooling Capacity	3.5 kW
Electrical Insulation Class	1
Energy Efficiency ratio (EER)	2.62

REFRIGERANT DATA

This product contains hermetically sealed non refillable gas	
Type	R290
Volume	245 g
Global Warming Potential (GWP) Value	3
CO ² Equivalent	0.000735 T

SAFETY INSTRUCTIONS

- Carefully read the instructions before operating the unit.
- This air conditioner is for indoor use only.
- This air conditioner must be only connected to a 230 V / 50 Hz earthed outlet.
- Installation must be in accordance with regulations of the country where the air conditioner is used.
- If you are in any doubt about the suitability of your electrical supply have it checked and, if necessary, modified by a qualified electrician.
- This air conditioner has been tested and is safe to use. However, as with any electrical appliance - use it with care.
- Disconnect the power plug from socket before dismantling, assembling or cleaning.
- Avoid touching any moving parts within the air conditioner.
- **NEVER** insert fingers, pencils or any other objects through the guard
- This air conditioner can be used by children aged from 8 years and above and persons with reduced physical, sensory or mental capabilities or lack of experience and knowledge if they have been given supervision or instruction concerning use of the appliance in a safe way and understand the hazards involved. Children shall not play with the air conditioner. Cleaning and user maintenance shall not be made by children without supervision.
- **DO NOT** leave children unsupervised with this air conditioner.
- **DO NOT** clean the air conditioner by spraying it or immersing it in water.
- **NEVER** connect the air conditioner to an electrical outlet using an extension cable. If an outlet is not available, one should be installed by a qualified electrician.
- **NEVER** operate this air conditioner if the cable or plug is damaged. Make sure that the power cable is not stretched or exposed to sharp objects/ edges.
- A damaged supply cable should be replaced by the manufacturer or a qualified electrician in order to avoid a hazard.
- Any service other than regular cleaning or filter replacement should be performed by an authorized service representative. Failure to comply could result in a voided warranty.
- **DO NOT** use the air conditioner for any other purpose than its intended use.

- The air conditioner unit must always be stored and transported upright, otherwise irreparable damage may be caused to the compressor; if in doubt we suggest waiting at least 24 hours before starting the unit.
- Avoid restarting the air conditioning unit unless 3 minutes have passed since being turned off. This prevents damage to the compressor.
- **NEVER** use the mains plug or an external timer as a switch to start and stop the air conditioning unit. Use the provided ON/OFF button located on the control panel.
- Always place the air conditioner on a dry and stable surface.
- The air conditioner should not be installed in laundry or wet rooms
- The air conditioner must be placed in a room without sources of ignition (for example: open flames, an operating gas appliance or an operating electric heater).
- Condensation may form on the base of this air conditioner during use, **DO NOT** use on sensitive or absorbent floors.

R290 REFRIGERANT GAS



R290

R290 refrigerant gas complies with European environmental directives.

R290 has a low GWP (Global Warming Potential) of 3.

The air conditioner contains about 245 g of R290 refrigerant gas.

- Do not use or store in an unventilated space with an area smaller than 25m² per unit. The room must be such as to prevent stagnation of possible leaks of refrigerant gas as there could be a danger of fire or explosion hazard should the refrigerant come into contact with electric heaters, stoves or other sources of ignition.
- Refrigerant gas may be odourless.
- Do not use the product and contact the retailer for advice if damage has occurred to the unit which may have compromised the refrigerant system.
- Any repairs or maintenance must only be carried out on the unit by a suitably qualified engineer. Before opening and servicing the unit, the authorized engineer must be in possession of a copy of the manufacturer's service manual and must follow the safety information contained within it to ensure all hazards are minimized.
- The refrigerant system must not be perforated or punctured.

ENERGY SAVING AND UNIT SAFETY PROTECTION TIPS

- Do not cover or restrict the airflow from the outlet or inlet grills.
- For maximum performance the air conditioner should be situated at least 50 cm from the walls or other objects.
- Keep the filters clean. Under normal conditions, filters should only need cleaning once every two weeks. Since the filters remove airborne particles, more frequent cleaning may be necessary, depending on the air quality.
- For the initial start-up set the fan speed to maximum and the thermostat to 4-5 degrees lower than the current temperature. Thereafter, set the fan to low and set the thermostat to your desired setting.
- To protect the unit we recommend the unit should only be used when the room temperature is between 15°C and 35°C.

ENVIRONMENTAL PROTECTION



Recycle unwanted materials instead of disposing of them as waste. All unwanted accessories and packaging should be sorted and taken to a recycling centre for disposal in a manner which is compatible with the environment.



By purchasing this product, the customer is taking on the obligation to deal with its safe disposal in accordance with the Waste Electrical and Electronic Equipment regulations (WEEE).



In effect, this means that this product must not be disposed of with general household waste. It must be disposed of according to the laws governing Waste Electrical and Electronic Equipment (WEEE) at a recognised disposal facility.

Under the Waste Batteries and Accumulators Regulations Act 2009, Clarke International are required to inform the owner of products containing batteries (as defined within these regulations), that they must also be disposed of at a recycling centre or suchlike facility.

ELECTRICAL CONNECTIONS



WARNING! READ THESE ELECTRICAL SAFETY INSTRUCTIONS THOROUGHLY BEFORE CONNECTING THE PRODUCT TO THE MAINS SUPPLY.

Before switching the product on, make sure that the voltage of your electricity supply is the same as that indicated on the rating plate. This product is designed to operate on 230 V AC 50Hz. Connecting it to any other power source may cause damage.

This product may be fitted with a non-rewireable plug. If it is necessary to change the fuse in the plug, the fuse cover must be refitted. If the fuse cover becomes lost or damaged, the plug must not be used until a suitable replacement is obtained.

If the plug has to be changed because it is not suitable for your socket, or due to damage, it should be cut off and a replacement fitted, following the wiring instructions shown below. The old plug must be disposed of safely, as insertion into a mains socket could cause an electrical hazard.

If the colours of the wires in the power cable of this product do not correspond with the markings on the terminals of your plug, proceed as follows.

- The **Blue** wire must be connected to the terminal which is marked **N**.
- The **Brown** wire must be connected to the terminal which is marked **L**.
- The **Yellow and Green** wire must be connected to the terminal which is marked **E** or

Plug must be BS1363/A approved.

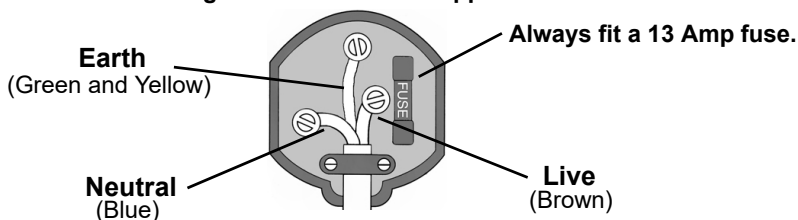

Ensure that the outer sheath of the cable is firmly held by the clamp

We strongly recommend that this machine is connected to the mains supply via a Residual Current Device (RCD)

If in any doubt, consult a qualified electrician. DO NOT attempt any repairs yourself.

OVERVIEW

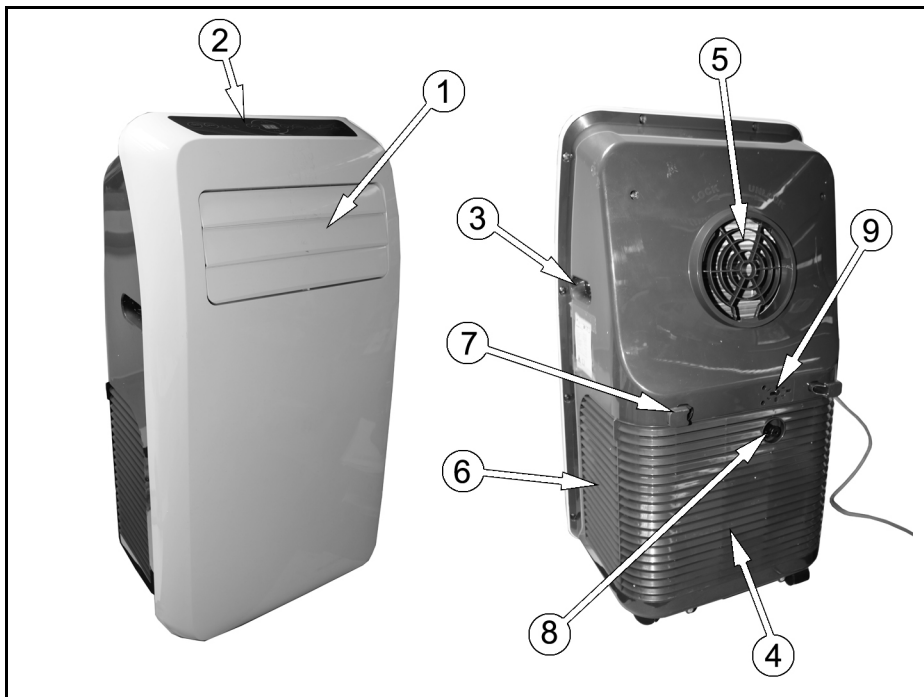

No	DESCRIPTION	No	DESCRIPTION
1	Air Outlet Flap	6	Air Filter Frame (side)
2	Control Panel	7	Power Cable Storage Hooks
3	Handle	8	Drainage Cap and Plug
4	Air Intake (rear)	9	Plug Storage Socket
5	Air Outlet Port (for ducting)		

CONTROL PANEL AND REMOTE CONTROL UNIT

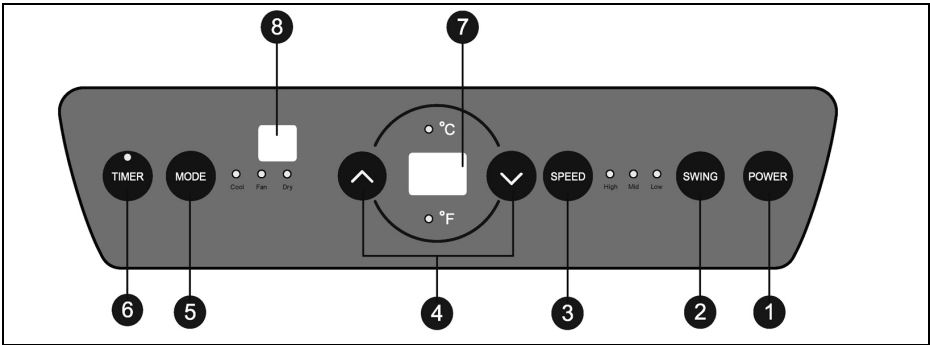

1. Power Button

Press the button to turn the air conditioner ON/OFF.

2. Swing Button

Pressing the swing button makes the louvres move up and down.

3. Speed Button

Press the speed button to select between High / Mid / Low speed.

4. Temp/Time adjustment buttons

5. Mode Button

Press the mode button to select between cooling / fan and dehumidification.

6. Timer Button

In standby mode, press the button to set the ON time.

When the air conditioner is on, press the button to set the OFF time.

7. Display Window

8. Remote Sensor

9. °C / °F Switching Button

Press the button to switch between °C / °F.

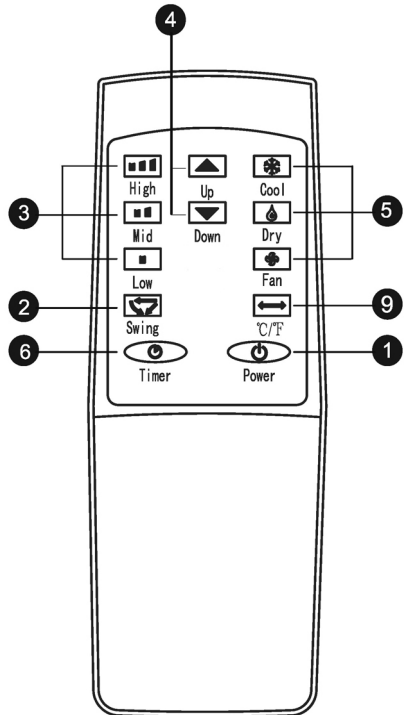

CONTENTS

The following components are supplied in the box;

1. Air Conditioner
2. Exhaust Duct Set
3. Remote Control Unit (including 2 x AAA batteries)
4. Window Kit

Should any loss or damage be apparent, please contact your CLARKE dealer immediately.

INSTALLATION

IMPORTANT: Do not position your air conditioner where it will be exposed to sources of heat above 35°C.

1. Always transport the air conditioner upright or resting on one side. Remember to drain the tank before moving the appliance.
2. Position the unit on a level, dry surface at least 50 cm away from surrounding objects.

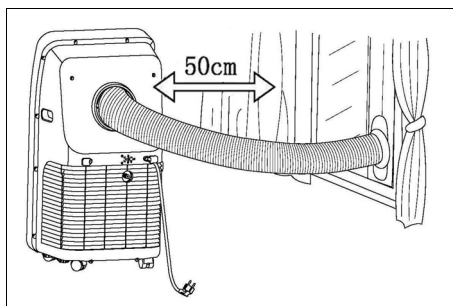

3. Screw the air exhaust duct on to the air outlet located on the rear of the air conditioner.
4. Insert the other end of the air exhaust duct into the window sealing plate.

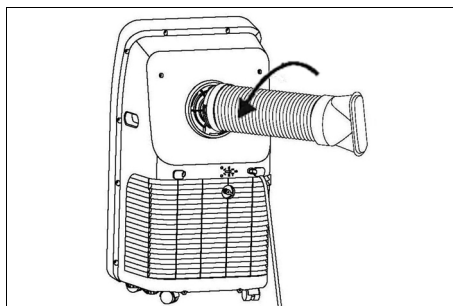

5. Move the air conditioner into position and extend the flexible exhaust duct to suit your window layout.

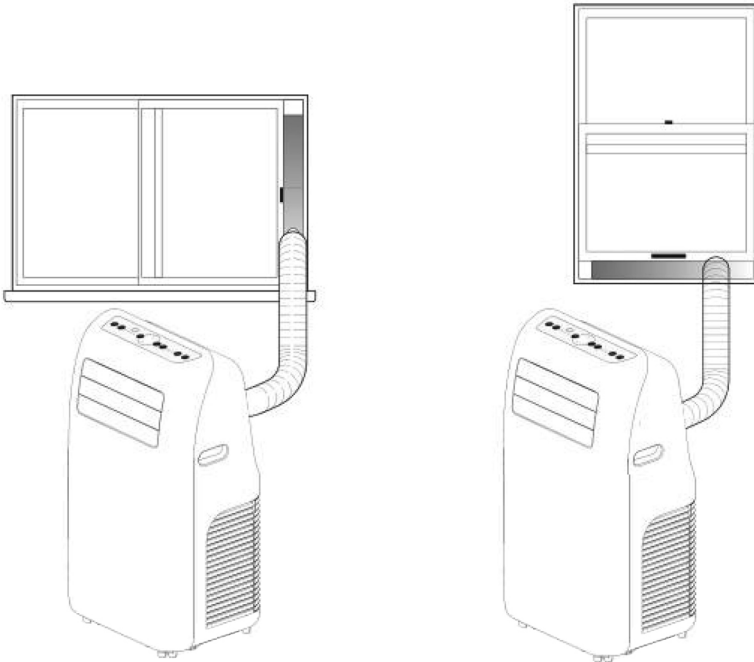

NOTE: The length of the exhaust duct is variable between 480mm and 1500mm (adaptors included). Using a shorter length of ducting uses less energy.

NOTE: The length of duct has been designed to suit the specification of the air conditioner. Do not use an extension or change to a different size duct as it may lead to poor performance.

6. The flexible exhaust ducting can be bent to an angle if followed by a straight section but tight curves and kinks must always be avoided.

7. Extend the two parts of the window sealing plate and fit into the window opening, below or beside the window panel as shown above.

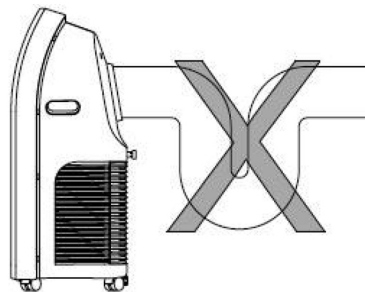

8. Secure in position by closing the window, or if not secure, wedge or otherwise secure the window slider plate so that it cannot fall out.

FITTING BATTERIES

1. Slide the battery cover away as indicated by the arrow on the rear of the remote control.
- Fit 2 x AAA batteries into the battery compartment following the polarity diagram inside.

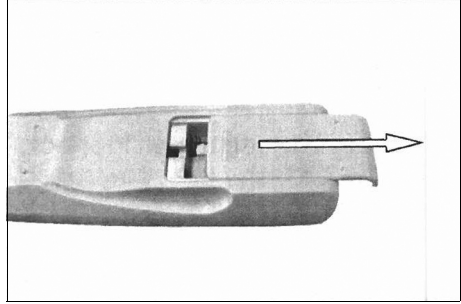

OPERATION

GENERAL OPERATION

- If the room is exposed to direct sunlight, draw any curtains during the sunniest part of the day.
1. Press the Power button to switch the air conditioner On/Off.
- The unit will select the last mode used.

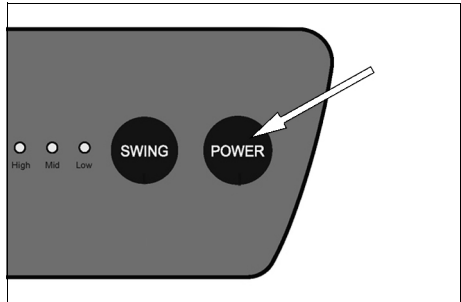

COOLING MODE (COOL)

1. Press the mode button repeatedly to select COOL.
- The cool indicator lamp lights up.
2. Press the Temp/Time adjustment buttons to select the temperature between 16 °C - 30 °C.
 3. Press the speed button to select between High / Mid / Low speed.
 4. Press the swing button to set the air outlet flap moving up and down to circulate the air more freely if required.

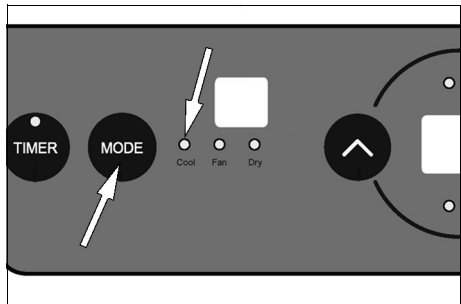

FAN MODE (FAN)

1. Press the mode button repeatedly to select FAN.
 - The FAN indicator lamp lights up.
2. Press the speed button to select between High / Mid / Low speed.

NOTE: In fan mode, you cannot set the temperature.

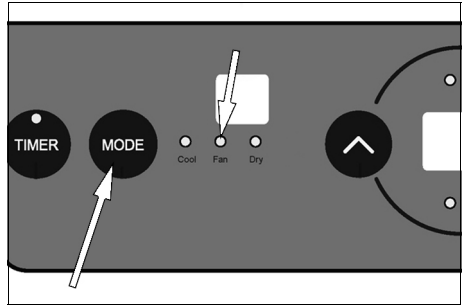

DEHUMIDIFYING MODE (DRY)

1. Remove the drain cap / plug from the rear of the air conditioner and connect the drainage hose to the outlet.
2. Place the other end of the drainage hose into a bucket.

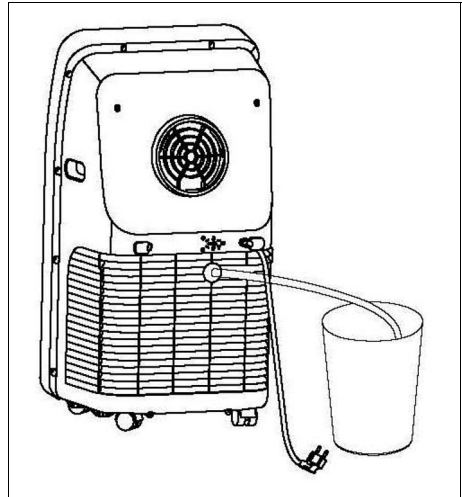

3. Press the mode button repeatedly to select DRY.

- The dry indicator lamp lights up.
- If the room temperature is above 17°C (62°F), the fan will come on.
- It will go off again if the room temperature drops below 15°C (59°F).
- In dehumidify mode, the fan runs at low speed and cannot be adjusted.
- The temperature setting cannot be adjusted in dehumidifying mode.

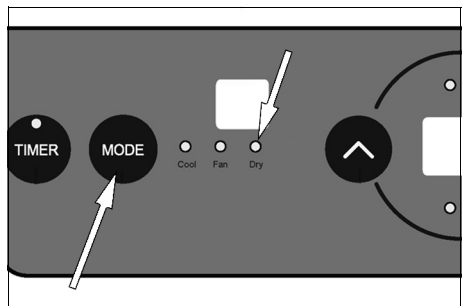

TIMER MODE

TO SET THE “ON” TIME (IN STANDBY MODE)

1. Press the Timer button to set the ON time.
2. Press the Time adjustment buttons to set the ON time (1-24 hours).
 - The timer indicator lamp lights up.

TO SET THE “OFF” TIME (WHEN THE AIR CONDITIONER IS ON)

1. Press the Timer button to set the OFF time.
2. Press the Time adjustment buttons to set the OFF time (1-24 hours).
 - The timer indicator lamp lights up.

FAULT CODES

The following fault codes can be displayed on the control panel.

Code	Diagnosis of Fault	Action Required
E1	Coil temp is abnormal.	Return to CLARKE Service Department for repair.
E2	Room temp is abnormal.	Return to CLARKE Service Department for repair.
E4	Anti-freezing protection.	None, will recover automatically when the temperature exceeds 8°C.
FL	Water is full inside the machine.	Drain water from the drain port at the bottom rear of the unit.

DRAINING OFF THE WATER

MANUAL DRAINAGE:

1. When the internal water tank is full, the unit will stop working and show “FL” on the display panel.
2. Turn off the unit using the power button and unplug from the mains. Try not to move the air conditioner abruptly as this may cause water to spill out from the internal water tank.
3. Place a tray under the drain port.

4. Remove the drain cap / plug from the drain port - water will drain from the water tank.
5. Once drained, replace the drain cap / plug and switch back on.

CONTINUOUS DRAINAGE

1. Remove the drain cap / plug from the drain port
2. Use a suitably sized water pipe to connect to the drain port.
3. You can plumb this pipe into your current plumbing system, lead it outside or use a water pump.
4. Note: This model has a self-evaporative function, which reduces the need to empty the water tank.

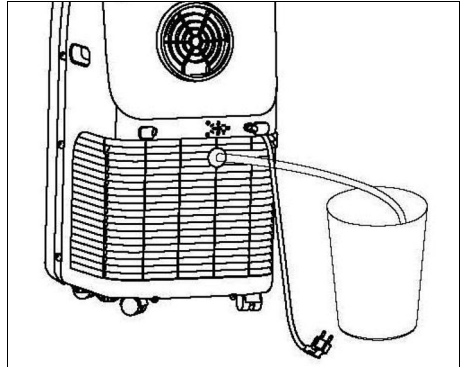

NOTE: If the unit is vented correctly most of the water is reused to cool the condenser coils and any excess is evaporated.

NOTE: Please do not use continuous drainage if you intend to use the self-evaporating facility.

MAINTENANCE

CLEANING



WARNING: PLEASE SHUT OFF THE UNIT AND UNPLUG FROM THE MAINS BEFORE CLEANING OR PERFORMING ANY MAINTENANCE.

1. Clean the outside surfaces of the unit with a duster or a soft, moist cloth.
 - Do not use solvents which could damage the plastic components.

CLEANING THE AIR FILTERS

Clean the air filters every 2 weeks. If the air filter is blocked with dust, performance will be affected.

1. Remove the rear grille.

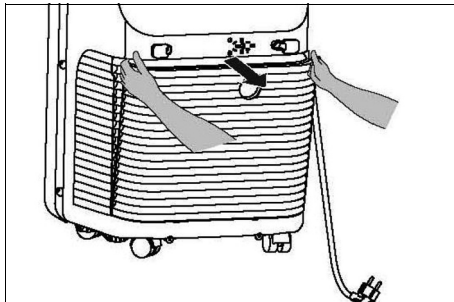

2. Slide out the 3 air filters.

NOTE: One of the filters is attached to the rear grille.

3. Wash the air filters gently in warm water with a mild detergent.
 4. Rinse the filters and dry them gently out of direct sunlight.
- Make sure the filters are dry before use.

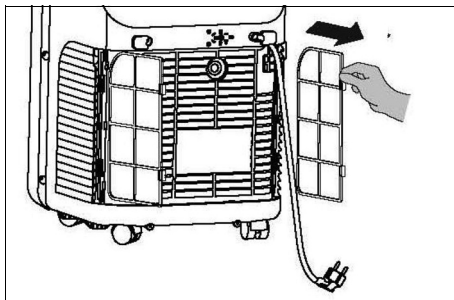

5. Clip the filters back into position and re-fit the grille.

END OF SEASON CLEANING

If the air conditioner is not going to be used for a long time:

1. Drain the internal water tank (page 13).
2. Run the air conditioner in fan mode for 2 hours to dry out the inside.
3. Switch off the unit and disconnect the power cable. Coil it around the hooks at the back of the machine and set the plug in the socket provided.
4. Clean the filters.
5. Dismantle the exhaust ducting and store it safely.
6. Remove the batteries from the remote control to preserve battery life.
7. Cover the air conditioner with a plastic bag and store it in a dry place.

TROUBLESHOOTING

Problem	Cause	Solution
The unit fails to operate	Unit is not plugged in.	Plug the unit into a suitable power source.
	Water tank is full (display shows "FL")	Drain the water container.
	Room temperature is unsuitable.	Check that room temperature is between 15°C - 35°C
Inefficient cooling	Unit is in direct sunlight.	Draw the curtains
	Doors or windows open or another heat source in the room.	Close windows/doors. Remove the heat source.
	Filter screen is dirty.	Clean the filter screen
	Air inlet or air outlet is blocked.	Remove the blockage
	Exhaust air hose not connected properly.	Connect the Exhaust air hose properly.
Noise or vibration	Is the unit standing on an uneven surface?	Stand the unit on a flat, firm surface.
	Flowing noise from inside the air conditioner	This is normal, it is refrigerant being circulated
Compressor doesn't work	Heat protection circuit has cut in.	Wait 3 minutes before re-starting unit.
The remote control doesn't work	The unit is too far away.	Move closer to the unit.
	Batteries are flat.	Replace the batteries.
	Remote control not pointing at the air conditioner.	Aim the remote control at the unit.

GUARANTEE

This CLARKE product is guaranteed against faulty manufacture for a period of 12 months from the date of purchase. Please keep your receipt as proof of purchase.

This guarantee is invalid if the product is found to have been abused or tampered with in any way, or not used for the purpose for which it was intended.

Faulty goods should be returned to their place of purchase, no product can be returned to us without prior permission. This guarantee does not affect your statutory rights.

AC13050 COMPONENT PARTS

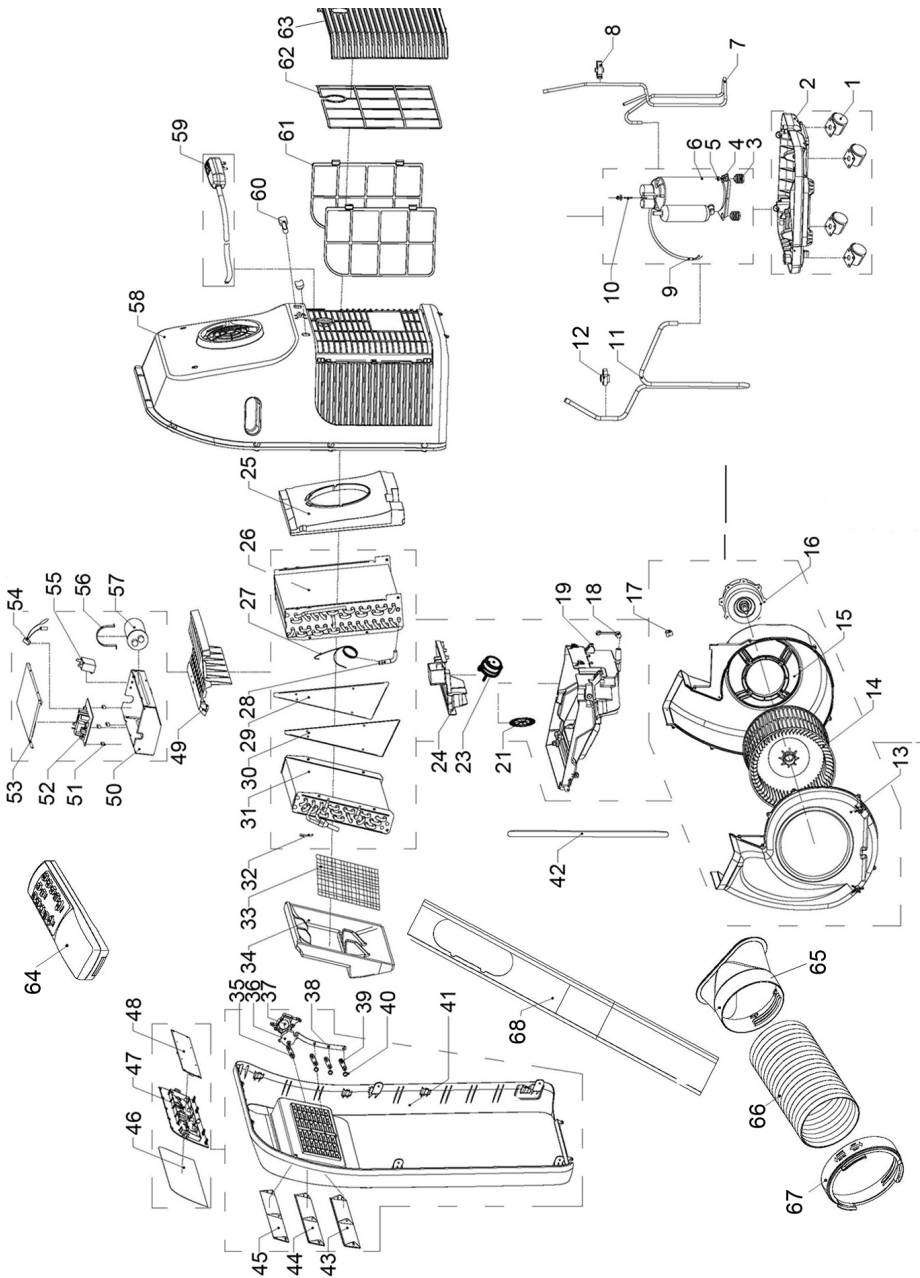

No	Description
1	Wheel
2	Chassis
3	Compressor foot pad
4	Gasket
5	Nut
6	Compressor assembly
7	Exhaust pipe
8	Exhaust pipe dumping rubber
9	Compressor cable assembly
10	Compressor bushing
11	Air suction pipe
12	Air suction pipe dumping rubber
13	Air duct - left
14	Air wheel
15	Air duct - right
16	Air exhaust motor
17	Power line card
18	Water plug
19	Water pan
20	n/a
21	Pumping wheel
22	n/a
23	Pumping motor
24	Water pan cover
25	Air outlet foam
26	Condenser assembly
27	Capillary
28	Strainer
29	Side plate - left
30	Side plate - right
31	Evaporator
32	Coil card
33	Safety net
34	Air outlet foam

No	Description
35	Driving rocker
36	Step motor
37	Swing motor base
38	Connecting rod
39	Driven rocker
40	Shaft sleeve
41	Front panel
42	Support strip
43	Air deflecting strip (lower)
44	Air deflecting strip (middle)
45	Air deflecting strip (upper)
46	Display board face film
47	Control panel
48	Electric control display panel
49	Air dust diaphragm
50	Electric control box
51	Isolating column
52	Main PCB
53	Control box cover
54	Sensor assembly
55	Fan capacitor
56	Capacitor card
57	Compressor capacitor
58	Rear panel
59	Power cable
60	Power line hook
61	Strainer -small
62	Strainer-large
63	Air inlet grille
64	Remote control
65	Air exhaust flat nozzle
66	Air exhaust hose
67	Air exhaust joint
68	Window sealplate assembly

DECLARATIONS OF CONFORMITY





Clarke
INTERNATIONAL

Hermill Hill, Fitzwilliam Place, Dublin 2

DECLARATION OF CONFORMITY

This is an important document and should be retained.

We hereby declare that this product(s) complies with the following directive(s):

- 2014/30/EU Electromagnetic Compatibility Directive
- 2014/35/EU Low Voltage Equipment Directive
- 2011/65/EU Restriction of Hazardous Substances
- 2009/125/EC Eco-design Requirements for Energy Related Products

The following standards have been applied to the product(s):

- EN 55014-1:2017, EN 55014-2:2015, EN 61000-3-2:2014, EN 61000-3-3:2013, EN 60335-2-40:2003+A11:2004+A12:2005+A1:2006+A2:2009+A13:2012, EN 60335-1:2012+A11:2014+A13:2017, EN 62233:2008, IEC 62321-1:2013, IEC 62321-2:2015, IEC 62321-3-1:2013, IEC 62321-4:2013, IEC 62321-5:2013, IEC 62321-6:2015, IEC 62321-7-1:2015, IEC 62321-7-2:2017, IEC 62321-8:2017, ISO 17075-1:2015.

The CE mark was first applied in: 2020

The technical documentation required to demonstrate that the product(s) meet(s) the requirement(s) of the aforementioned directive(s) has been compiled and is available for inspection by the relevant enforcement authorities.

Product Description:	12000 BTU Portable Air Conditioner
Model number(s):	AC13050
Serial / batch Number:	N/A
Date of Issue:	31/10/2022

Signed: 

J.A. Clarke
Director

ACT1800 CE Clarke.DOC 103122

Page 1 of 1





Clarke
INTERNATIONAL

Hermill Street, Epping, Essex CM16 4LG

DECLARATION OF CONFORMITY

This is an important document and should be retained.

We hereby declare that this product(s) complies with the following statutory requirement(s):

- Electromagnetic Compatibility Regulations 2016
- Electrical Equipment (Safety) Regulations 2016
- The Restriction of the Use of Certain Hazardous Substances in Electrical and Electronic Equipment Regulations 2012
- The Eco-design for Energy-Related Products and Energy Information (Amendment) (EU) (EU) (Ext) Regulations 2019

The following standards have been applied to the product(s):

- EN 55014-1:2017, EN 55014-2:2015, EN 61000-3-2:2014, EN 61000-3-3:2013, EN 60335-2-40:2003+A11:2004+A12:2005+A1:2006+A2:2009+A13:2012, EN 60335-1:2012+A11:2014+A13:2017, EN 62233:2008, IEC 62321-1:2013, IEC 62321-2:2013, IEC 62321-3-1:2013, IEC 62321-4:2013, IEC 62321-5:2013, IEC 62321-6:2015, IEC 62321-7-1:2015, IEC 62321-7-2:2017, IEC 62321-8:2017, ISO 17075-1:2015.

The UKCA mark was first applied in: 2022

The technical documentation required to demonstrate that the product(s) meet(s) the requirement(s) of the aforementioned legislation has been compiled and is available for inspection by the relevant enforcement authorities.

Product Description:	12000 BTU Portable Air Conditioner
Model number(s):	AC13050
Serial / batch Number:	N/A
Date of Issue:	31/10/2022

Signed: 

J.A. Clarke
Director

ACT1800 UKCA Clarke.DOC 103122

Page 1 of 1

A SELECTION FROM THE VAST RANGE OF

Clarke®

QUALITY PRODUCTS



AIR COMPRESSORS

From DIY to industrial, Plus air tools, spray guns and accessories.

GENERATORS

Prime duty or emergency standby for business, home and leisure.

POWER WASHERS

Hot and cold, electric and engine driven - we have what you need

WELDERS

Mig, Arc, Tig and Spot. From DIY to auto/industrial.

METALWORKING

Drills, grinders and saws for DIY and professional use.

WOODWORKING

Saws, sanders, lathes, mortisers and dust extraction.

HYDRAULICS

Cranes, body repair kits, transmission jacks for all types of workshop use.

WATER PUMPS

Submersible, electric and engine driven for DIY, agriculture and industry.

POWER TOOLS

Angle grinders, cordless drill sets, saws and sanders.

STARTERS/CHARGERS

All sizes for car and commercial use.



PARTS & SERVICE: 0208 988 7400

Parts Enquiries
Parts@clarkeinternational.com

Servicing & Technical Enquiries
Service@clarkeinternational.com

SALES: UK 01992 565333 or Export 00 44 (0)1992 565335

Clarke INTERNATIONAL Hemnall Street, Epping, Essex CM16 4LG
www.clarkeinternational.com